



<IGBT Modules>

# CM450DX-24T/CM450DXP-24T

**HIGH POWER SWITCHING USE  
INSULATED TYPE**

 <p>DX</p>	<p>Collector current <math>I_C</math> ..... <b>4 5 0 A</b>            Collector-emitter voltage <math>V_{CES}</math> ..... <b>1 2 0 0 V</b>            Maximum junction temperature <math>T_{vjmax}</math> ..... <b>1 7 5 °C</b></p> <ul style="list-style-type: none"> <li>•PC-TIM applied optional</li> <li>•Copper base plate (Ni-plating)</li> <li>•RoHS Directive compliant</li> <li>•Tin plating pin terminals</li> </ul>
 <p>DXP</p>	<p>Collector current <math>I_C</math> ..... <b>4 5 0 A</b>            Collector-emitter voltage <math>V_{CES}</math> ..... <b>1 2 0 0 V</b>            Maximum junction temperature <math>T_{vjmax}</math> ..... <b>1 7 5 °C</b></p> <ul style="list-style-type: none"> <li>•PC-TIM applied optional</li> <li>•Copper base plate (Ni-plating)</li> <li>•RoHS Directive compliant</li> <li>•Tin plating pressfit terminals</li> </ul>
<p><b>dual switch (half-bridge)</b></p> <ul style="list-style-type: none"> <li>•Recognized under UL1557, File E323585</li> </ul>	

**APPLICATION**

AC Motor Control, Motion/Servo Control, Power supply, etc.

**INTERNAL CONNECTION**

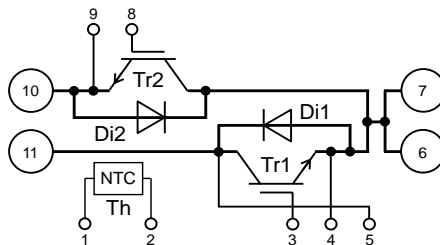

**TERMINAL CODE**

- |        |         |
|--------|---------|
| 1. TH1 | 6. C2E1 |
| 2. TH2 | 7. C2E1 |
| 3. G1  | 8. G2   |
| 4. Es1 | 9. Es2  |
| 5. Cs1 | 10. E2  |
|        | 11. C1  |

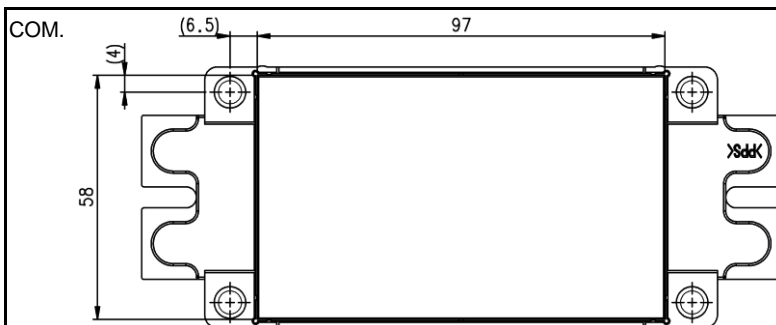

**MOUNTING HOLES**

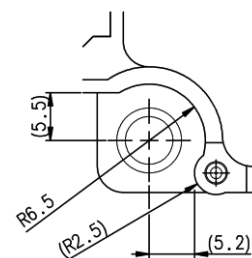

**SECTION A**

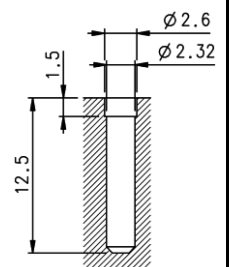

Tolerance otherwise specified

Division of Dimension	Tolerance
0.5 to 3	±0.2
over 3 to 6	±0.3
over 6 to 30	±0.5
over 30 to 120	±0.8
over 120 to 400	±1.2

# CM450DX-24T/CM450DXP-24T

HIGH POWER SWITCHING USE  
INSULATED TYPE

## OUTLINE DRAWING

Dimension in mm

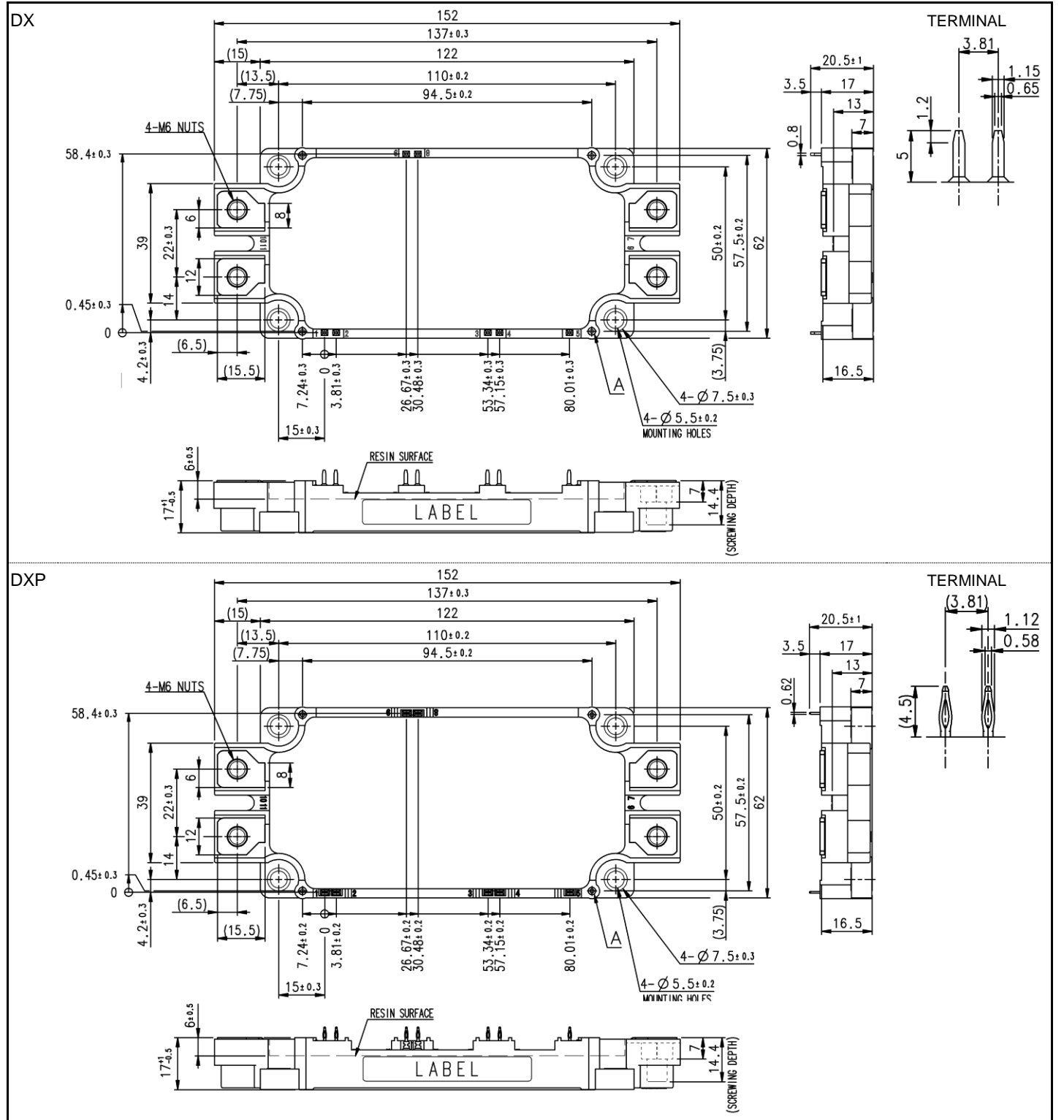

# CM450DX-24T/CM450DXP-24T

HIGH POWER SWITCHING USE  
INSULATED TYPE

## MAXIMUM RATINGS (T<sub>vj</sub>=25 °C, unless otherwise specified)

### INVERTER PART IGBT/FWD

Symbol	Item	Conditions	Rating	Unit
V <sub>CES</sub>	Collector-emitter voltage	G-E short-circuited	1200	V
V <sub>GES</sub>	Gate-emitter voltage	C-E short-circuited	± 20	V
I <sub>C</sub>	Collector current	DC, T <sub>C</sub> =118 °C (Note2, 4)	450	A
I <sub>CRM</sub>		Pulse, Repetitive (Note3)	900	
P <sub>tot</sub>	Total power dissipation	T <sub>C</sub> =25 °C (Note2, 4)	2500	W
I <sub>E</sub> (Note1)	Emitter current	DC (Note2)	450	A
I <sub>ERM</sub> (Note1)		Pulse, Repetitive (Note3)	900	

### MODULE

Symbol	Item	Conditions	Rating	Unit
V <sub>isol</sub>	Isolation voltage	Terminals to base plate, RMS, f=60 Hz, AC 1 min	2500	V
T <sub>vjmax</sub>	Maximum junction temperature	Instantaneous event (overload)	175	°C
T <sub>Cmax</sub>	Maximum case temperature	(Note4)	125	
T <sub>vjop</sub>	Operating junction temperature	Continuous operation (under switching)	-40 ~ +150	°C
T <sub>stg</sub>	Storage temperature	-	-40 ~ +125	

## ELECTRICAL CHARACTERISTICS (T<sub>vj</sub>=25 °C, unless otherwise specified)

### INVERTER PART IGBT/FWD

Symbol	Item	Conditions	Limits			Unit	
			Min.	Typ.	Max.		
I <sub>CES</sub>	Collector-emitter cut-off current	V <sub>CE</sub> =V <sub>CES</sub> , G-E short-circuited	-	-	1.0	mA	
I <sub>GES</sub>	Gate-emitter leakage current	V <sub>GE</sub> =V <sub>GES</sub> , C-E short-circuited	-	-	0.5	µA	
V <sub>GE(th)</sub>	Gate-emitter threshold voltage	I <sub>C</sub> =45 mA, V <sub>CE</sub> =10 V	5.4	6.0	6.6	V	
V <sub>CEsat</sub> (Terminal)	Collector-emitter saturation voltage	I <sub>C</sub> =450 A, V <sub>GE</sub> =15 V, Refer to the figure of test circuit (Note5)	T <sub>vj</sub> =25 °C	-	1.65	2.05	V
V <sub>CEsat</sub> (Chip)			T <sub>vj</sub> =125 °C	-	1.85	-	
			T <sub>vj</sub> =150 °C	-	1.90	-	
V <sub>CEsat</sub> (Chip)	Collector-emitter saturation voltage	I <sub>C</sub> =450 A, V <sub>GE</sub> =15 V, (Note5)	T <sub>vj</sub> =25 °C	-	1.50	1.75	V
			T <sub>vj</sub> =125 °C	-	1.70	-	
			T <sub>vj</sub> =150 °C	-	1.75	-	
C <sub>ies</sub>	Input capacitance	V <sub>CE</sub> =10 V, G-E short-circuited	-	-	109.1	nF	
C <sub>oes</sub>	Output capacitance		-	-	3.1		
C <sub>res</sub>	Reverse transfer capacitance		-	-	1.4		
Q <sub>G</sub>	Gate charge	V <sub>CC</sub> =600 V, I <sub>C</sub> =450 A, V <sub>GE</sub> =15 V	-	3.4	-	µC	
t <sub>d(on)</sub>	Turn-on delay time	V <sub>CC</sub> =600 V, I <sub>C</sub> =450 A, V <sub>GE</sub> =±15 V, R <sub>G</sub> =1.3 Ω, Inductive load	-	-	600	ns	
t <sub>r</sub>	Rise time		-	-	200		
t <sub>d(off)</sub>	Turn-off delay time		-	-	800		
t <sub>f</sub>	Fall time		-	-	400		
V <sub>EC</sub> (Terminal) (Note1)	Emitter-collector voltage	I <sub>E</sub> =450 A, G-E short-circuited, Refer to the figure of test circuit (Note5)	T <sub>vj</sub> =25 °C	-	1.70	2.25	V
V <sub>EC</sub> (Chip) (Note1)			T <sub>vj</sub> =125 °C	-	1.85	-	
			T <sub>vj</sub> =150 °C	-	1.90	-	
V <sub>EC</sub> (Chip) (Note1)	Emitter-collector voltage	I <sub>E</sub> =450 A, G-E short-circuited, (Note5)	T <sub>vj</sub> =25 °C	-	1.50	1.85	V
			T <sub>vj</sub> =125 °C	-	1.50	-	
			T <sub>vj</sub> =150 °C	-	1.50	-	
t <sub>rr</sub> (Note1)	Reverse recovery time	V <sub>CC</sub> =600 V, I <sub>E</sub> =450 A, V <sub>GE</sub> =±15 V,	-	-	400	ns	
Q <sub>rr</sub> (Note1)	Reverse recovery charge	R <sub>G</sub> =1.3 Ω, Inductive load	-	35.1	-	µC	
E <sub>on</sub>	Turn-on switching energy per pulse	V <sub>CC</sub> =600 V, I <sub>C</sub> =I <sub>E</sub> =450 A,	-	40.8	-	mJ	
E <sub>off</sub>	Turn-off switching energy per pulse	V <sub>GE</sub> =±15 V, R <sub>G</sub> =1.3 Ω, T <sub>vj</sub> =150 °C,	-	45	-		
E <sub>rr</sub> (Note1)	Reverse recovery energy per pulse	Inductive load	-	32.4	-	mJ	
R <sub>CC'+EE'</sub>	Internal lead resistance	Main terminals-chip, per switch, T <sub>C</sub> =25 °C (Note4)	-	0.75	-	mΩ	
r <sub>g</sub>	Internal gate resistance	Per switch	-	0.67	-	Ω	

# CM450DX-24T/CM450DXP-24T

HIGH POWER SWITCHING USE  
INSULATED TYPE

## ELECTRICAL CHARACTERISTICS (cont.; T<sub>vj</sub>=25 °C, unless otherwise specified) NTC THERMISTOR PART

Symbol	Item	Conditions	Limits			Unit
			Min.	Typ.	Max.	
R <sub>25</sub>	Zero-power resistance	T <sub>C</sub> =25 °C (Note4)	4.85	5.00	5.15	kΩ
ΔR/R	Deviation of resistance	R <sub>100</sub> =493 Ω, T <sub>C</sub> =100 °C (Note4)	-7.3	-	+7.8	%
B <sub>(25/50)</sub>	B-constant	Approximate by equation (Note6)	-	3375	-	K
P <sub>25</sub>	Power dissipation	T <sub>C</sub> =25 °C (Note4)	-	-	10	mW

## THERMAL RESISTANCE CHARACTERISTICS

Symbol	Item	Conditions	Limits			Unit
			Min.	Typ.	Max.	
R <sub>th(j-c)Q</sub>	Thermal resistance	Junction to case, per Inverter IGBT (Note4)	-	-	60	K/kW
R <sub>th(j-c)D</sub>		Junction to case, per Inverter FWD (Note4)	-	-	87	
R <sub>th(c-s)</sub>	Contact thermal resistance	Case to heat sink, Thermal grease applied (Note4, 7)	-	11.5	-	K/kW
		per 1 module, PC-TIM applied (Note4, 8)	-	3.1	-	

## MECHANICAL CHARACTERISTICS

Symbol	Item	Conditions	Limits			Unit	
			Min.	Typ.	Max.		
M <sub>t</sub>	Mounting torque	Main terminals M 6 screw	3.5	4.0	4.5	N·m	
M <sub>s</sub>	Mounting torque	Mounting to heat sink M 5 screw	2.5	3.0	3.5	N·m	
d <sub>s</sub>	Creepage distance	Solder pin type (DX)	Terminal to terminal	17	-	-	mm
			Terminal to base plate	16.4	-	-	
		Pressfit pin type (DXP)	Terminal to terminal	17	-	-	mm
			Terminal to base plate	16.8	-	-	
d <sub>a</sub>	Clearance	Solder pin type (DX)	Terminal to terminal	10	-	-	mm
			Terminal to base plate	16.2	-	-	
		Pressfit pin type (DXP)	Terminal to terminal	10	-	-	mm
			Terminal to base plate	16.2	-	-	
e <sub>c</sub>	Flatness of base plate	On the centerline X, Y (Note9)	±0	-	+200	μm	
m	mass	-	-	300	-	g	

\*: This product is compliant with the Restriction of the Use of Certain Hazardous Substances in Electrical and Electronic Equipment (RoHS) directive 2011/65/EU.

Note1. Represent ratings and characteristics of the anti-parallel, emitter-collector free-wheeling diode (FWD).

- Junction temperature (T<sub>vj</sub>) should not increase beyond T<sub>vjmax</sub> rating.
- Pulse width and repetition rate should be such that the device junction temperature (T<sub>vj</sub>) dose not exceed T<sub>vjmax</sub> rating.
- Case temperature (T<sub>C</sub>) and heat sink temperature (T<sub>S</sub>) are defined on the each surface (mounting side) of base plate and heat sink just under the chips.  
Refer to the figure of chip location.
- Pulse width and repetition rate should be such as to cause negligible temperature rise. Refer to the figure of test circuit.

$$6. B_{(25/50)} = \ln\left(\frac{R_{25}}{R_{50}}\right) / \left(\frac{1}{T_{25}} - \frac{1}{T_{50}}\right)$$

R<sub>25</sub>: resistance at absolute temperature T<sub>25</sub> [K]; T<sub>25</sub>=25 [°C]+273.15=298.15 [K]

R<sub>50</sub>: resistance at absolute temperature T<sub>50</sub> [K]; T<sub>50</sub>=50 [°C]+273.15=323.15 [K]

- Typical value is measured by using thermally conductive grease of λ=0.9 W/(m·K)/D<sub>(c-s)</sub>=50 μm.
- Typical value is measured by using PC-TIM of λ=3.4 W/(m·K)/D<sub>(c-s)</sub>=50 μm.
- The base plate (mounting side) flatness measurement points (X, Y) are shown in the following figure.

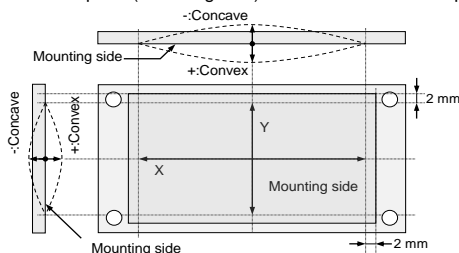

**CM450DX-24T/CM450DXP-24T**

HIGH POWER SWITCHING USE

INSULATED TYPE

Note10. Use the following screws when mounting the printed circuit board (PCB) on the standoffs.

The length of the screw depends on thickness (t1.0~t1.6) of the PCB.

Type	Size	Tightening torque	Recommended tightening method
(1) PT®	K25×8	0.55 ± 0.055 N·m	by handwork (equivalent to 30 r/min by mechanical screw driver) ~ 600 r/min (by mechanical screw driver)
(2) PT®	K25×10	0.75 ± 0.075 N·m	
(3) DELTA PT®	25×8	0.55 ± 0.055 N·m	
(4) DELTA PT®	25×10	0.75 ± 0.075 N·m	
(5) B1 tapping screw	φ2.6×10 or φ2.6×12	0.75 ± 0.075 N·m	

**RECOMMENDED OPERATING CONDITIONS**

Symbol	Item	Conditions	Limits			Unit
			Min.	Typ.	Max.	
$V_{CC}$	(DC) Supply voltage	Applied across C1-E2 terminals	-	600	850	V
$V_{GEon}$	Gate (-emitter drive) voltage	Applied across G1-E1s/G2-E2s terminals	13.5	15.0	16.5	V
$R_G$	External gate resistance	Per switch	1.3	-	10	Ω

# CM450DX-24T/CM450DXP-24T

HIGH POWER SWITCHING USE  
INSULATED TYPE

## CHIP LOCATION (Top view)

Dimension in mm, tolerance:  $\pm 1$  mm

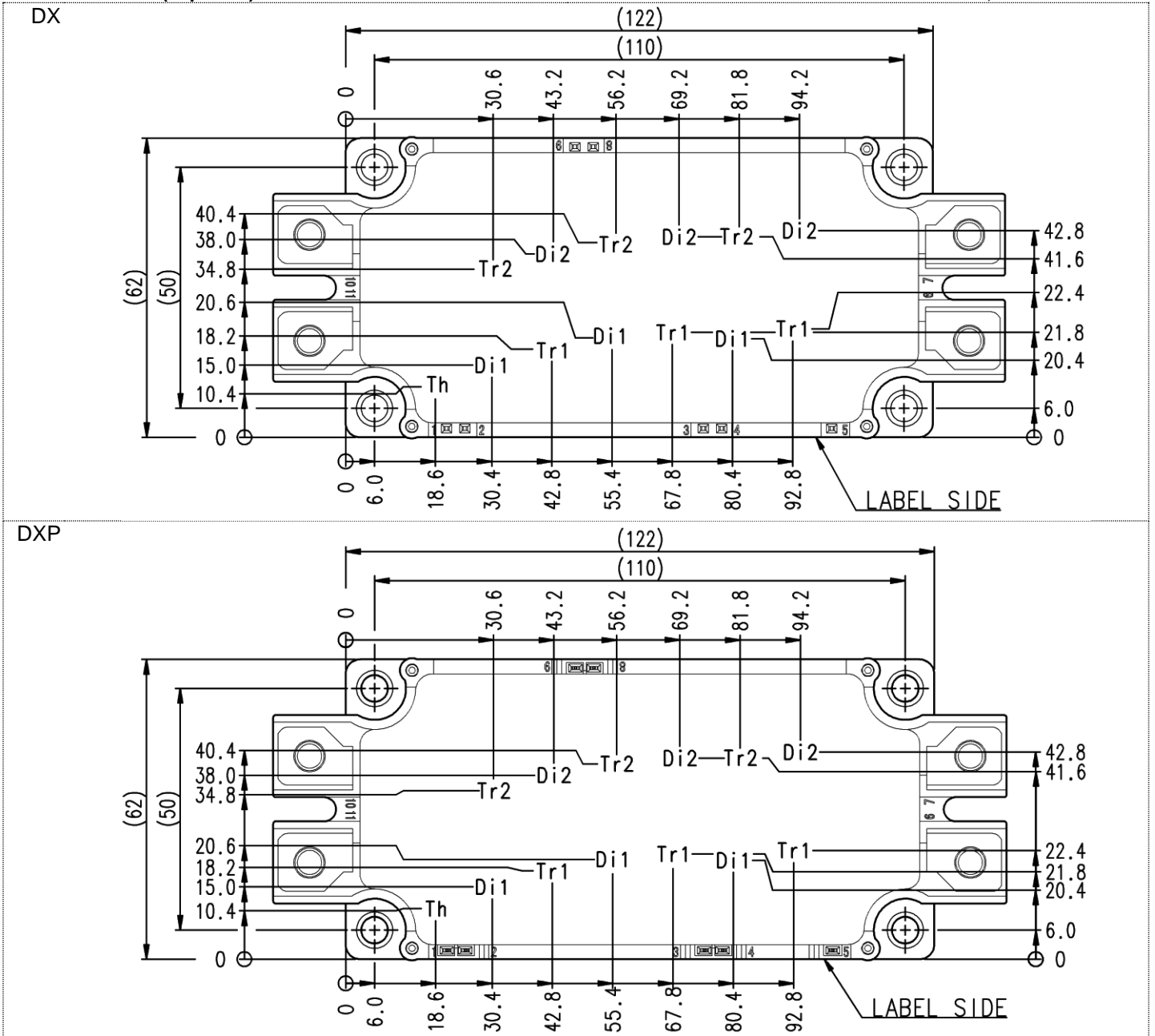

Tr1/Tr2: IGBT, Di1/Di2: FWD, Th: NTC thermistor

## PC-TIM applied (option) baseplate outline

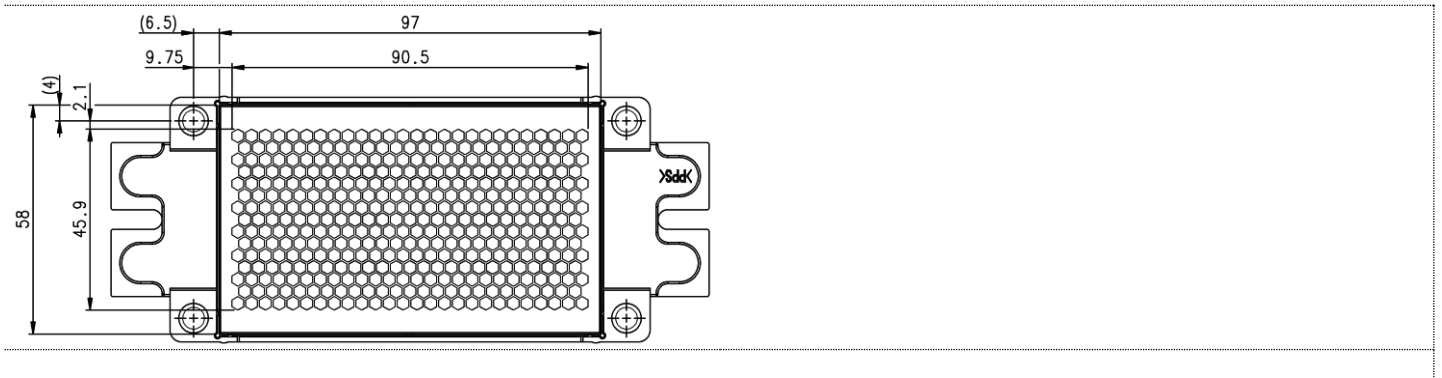

# CM450DX-24T/CM450DXP-24T

HIGH POWER SWITCHING USE  
INSULATED TYPE

## TEST CIRCUIT AND WAVEFORMS

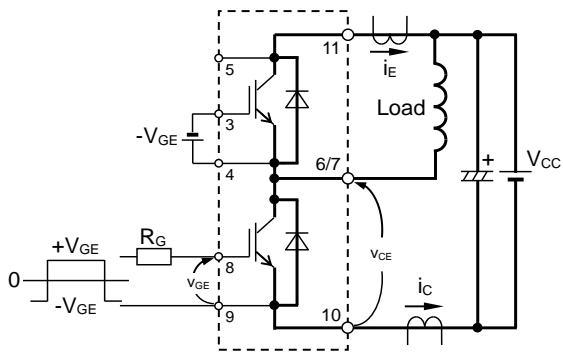

Switching characteristics test circuit and waveforms

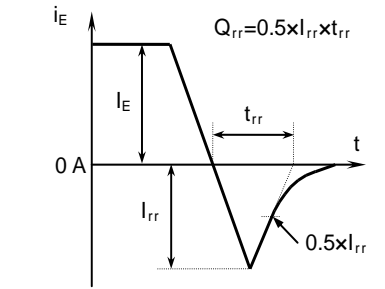
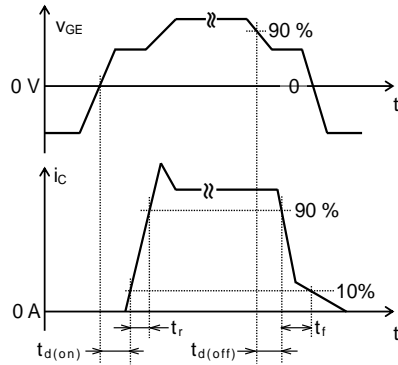

$t_{rr}$ ,  $Q_{rr}$  characteristics test waveform

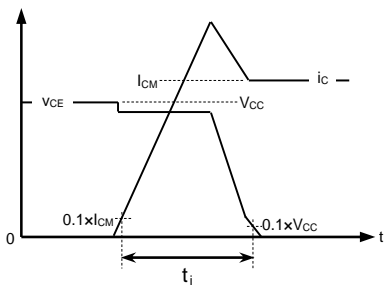

IGBT Turn-on switching energy

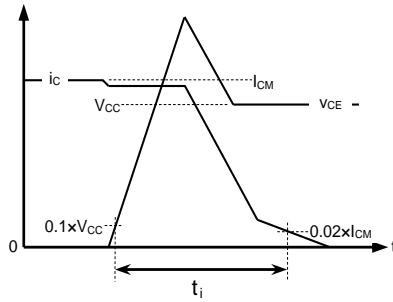

IGBT Turn-off switching energy

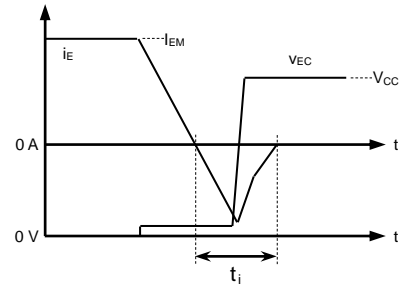

FWD Reverse recovery energy

Switching energy and Reverse recovery energy test waveforms (Integral time instruction drawing)

## TEST CIRCUIT

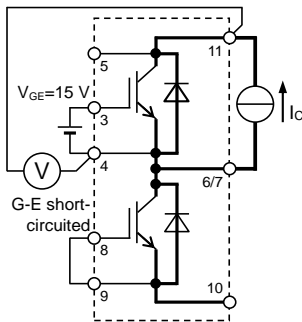

Tr1

$V_{CEsat}$  characteristics test circuit

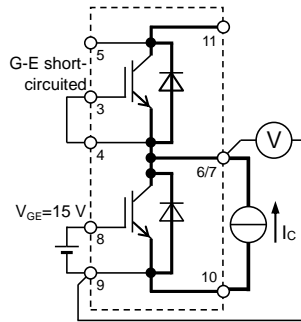

Tr2

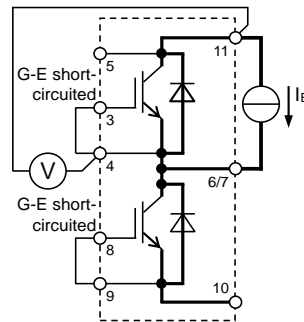

Di1

$V_{EC}$  characteristics test circuit

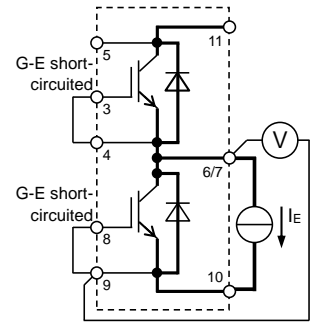

Di2

# CM450DX-24T/CM450DXP-24T

HIGH POWER SWITCHING USE  
INSULATED TYPE

## PERFORMANCE CURVES

### INVERTER PART

#### OUTPUT CHARACTERISTICS

(TYPICAL)

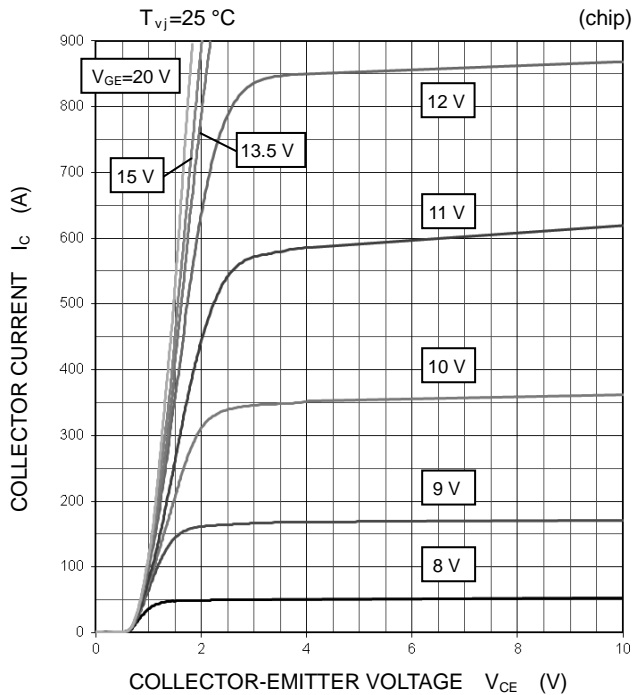

#### COLLECTOR-EMITTER SATURATION VOLTAGE CHARACTERISTICS

(TYPICAL)

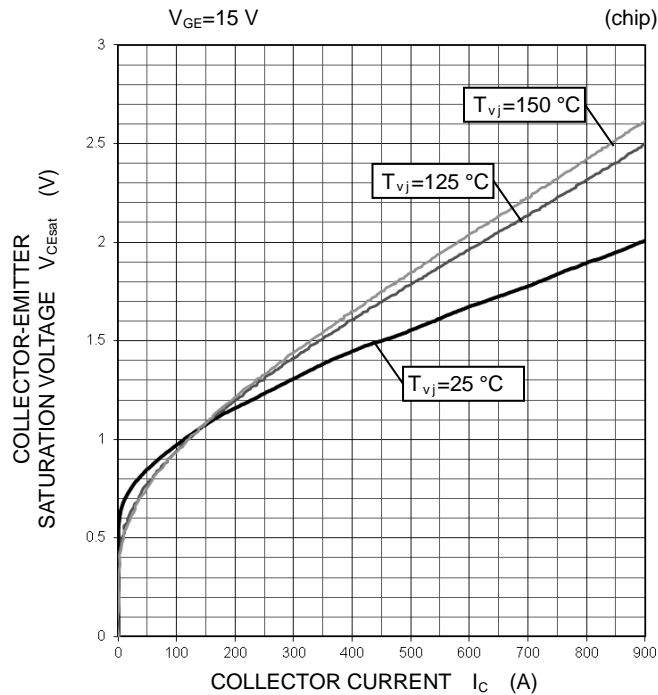

#### COLLECTOR-EMITTER SATURATION VOLTAGE CHARACTERISTICS

(TYPICAL)

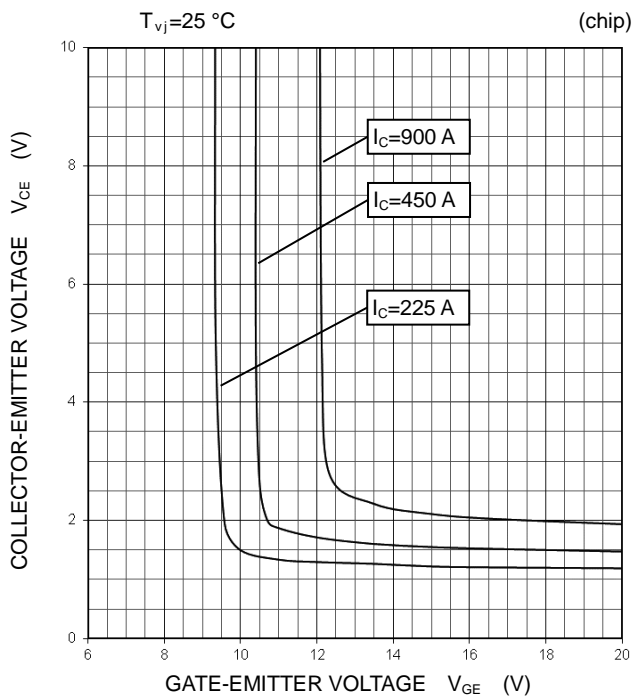

#### FREE WHEELING DIODE FORWARD CHARACTERISTICS

(TYPICAL)

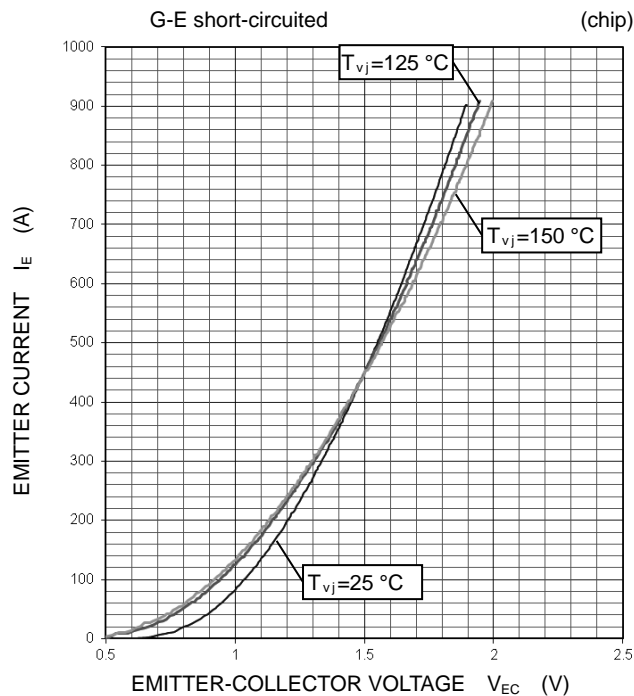



# CM450DX-24T/CM450DXP-24T

HIGH POWER SWITCHING USE  
INSULATED TYPE

## PERFORMANCE CURVES

### INVERTER PART

**HALF-BRIDGE SWITCHING CHARACTERISTICS (TYPICAL)**

$V_{CC}=600\text{ V}$ ,  $R_G=1.3\ \Omega$ ,  $V_{GE}=\pm 15\text{ V}$ , INDUCTIVE LOAD  
 —:  $T_{vj}=150\text{ }^\circ\text{C}$ , - - - -:  $T_{vj}=125\text{ }^\circ\text{C}$

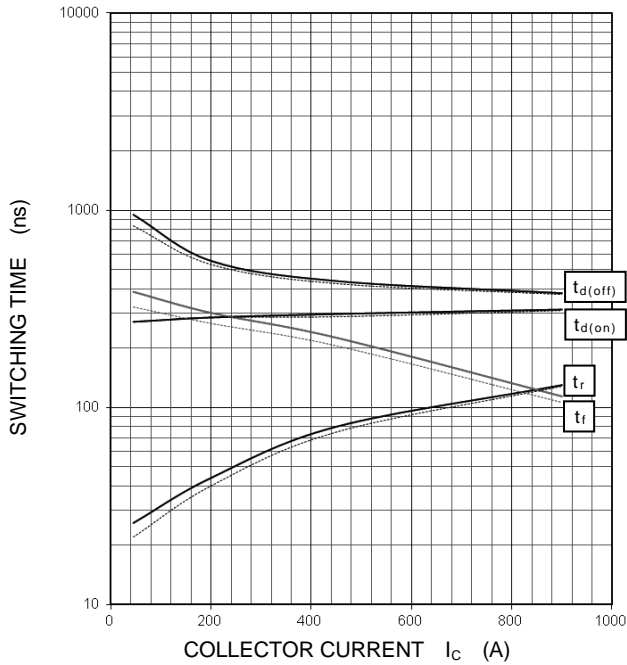

**HALF-BRIDGE SWITCHING CHARACTERISTICS (TYPICAL)**

$V_{CC}=600\text{ V}$ ,  $I_C=450\text{ A}$ ,  $V_{GE}=\pm 15\text{ V}$ , INDUCTIVE LOAD  
 —:  $T_{vj}=150\text{ }^\circ\text{C}$ , - - - -:  $T_{vj}=125\text{ }^\circ\text{C}$

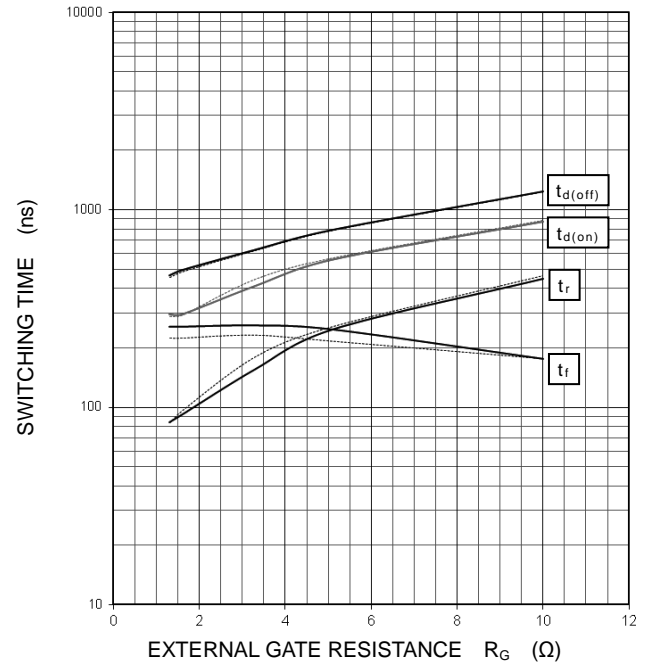

**HALF-BRIDGE SWITCHING CHARACTERISTICS (TYPICAL)**

$V_{CC}=600\text{ V}$ ,  $R_G=1.3\ \Omega$ ,  $V_{GE}=\pm 15\text{ V}$ , INDUCTIVE LOAD,  
 —:  $T_{vj}=150\text{ }^\circ\text{C}$ , - - - -:  $T_{vj}=125\text{ }^\circ\text{C}$ , PER PULSE

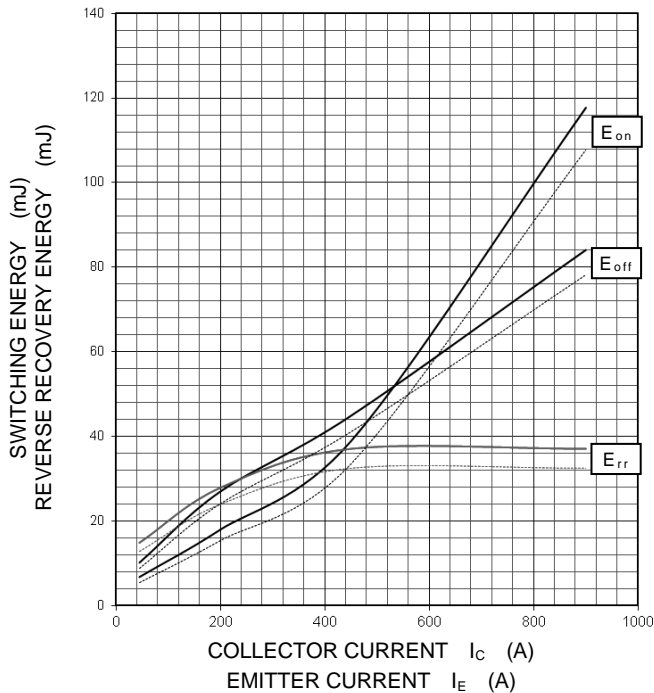

**HALF-BRIDGE SWITCHING CHARACTERISTICS (TYPICAL)**

$V_{CC}=600\text{ V}$ ,  $I_C/I_E=450\text{ A}$ ,  $V_{GE}=\pm 15\text{ V}$ , INDUCTIVE LOAD,  
 —:  $T_{vj}=150\text{ }^\circ\text{C}$ , - - - -:  $T_{vj}=125\text{ }^\circ\text{C}$ , PER PULSE

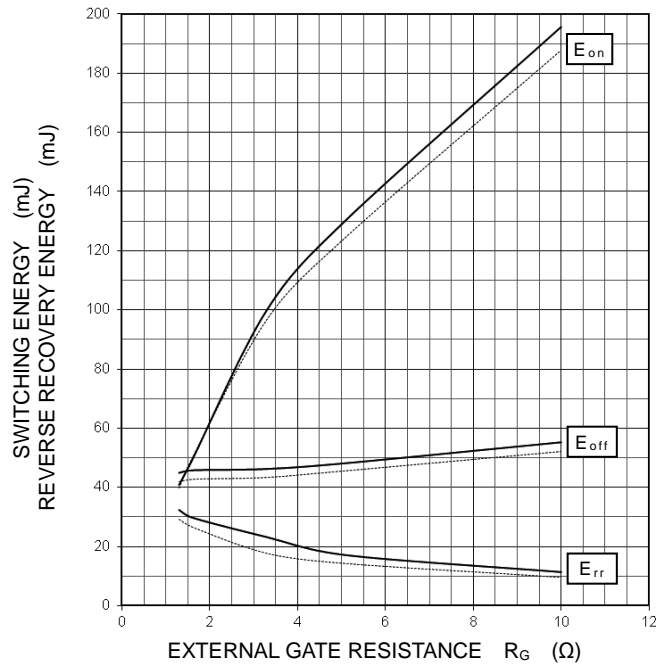

# CM450DX-24T/CM450DXP-24T

HIGH POWER SWITCHING USE  
INSULATED TYPE

## PERFORMANCE CURVES

### INVERTER PART

#### CAPACITANCE CHARACTERISTICS

(TYPICAL)

G-E short-circuited,  $T_{vj}=25\text{ }^{\circ}\text{C}$

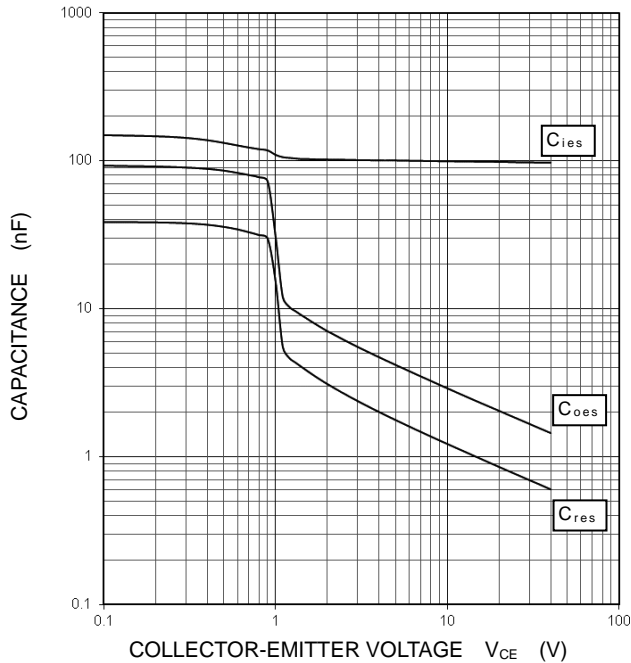

#### FREE WHEELING DIODE REVERSE RECOVERY CHARACTERISTICS

(TYPICAL)

$V_{CC}=600\text{ V}$ ,  $R_G=1.3\text{ }\Omega$ ,  $V_{GE}=\pm 15\text{ V}$ , INDUCTIVE LOAD  
—:  $T_j=150\text{ }^{\circ}\text{C}$ , - - - -:  $T_j=125\text{ }^{\circ}\text{C}$

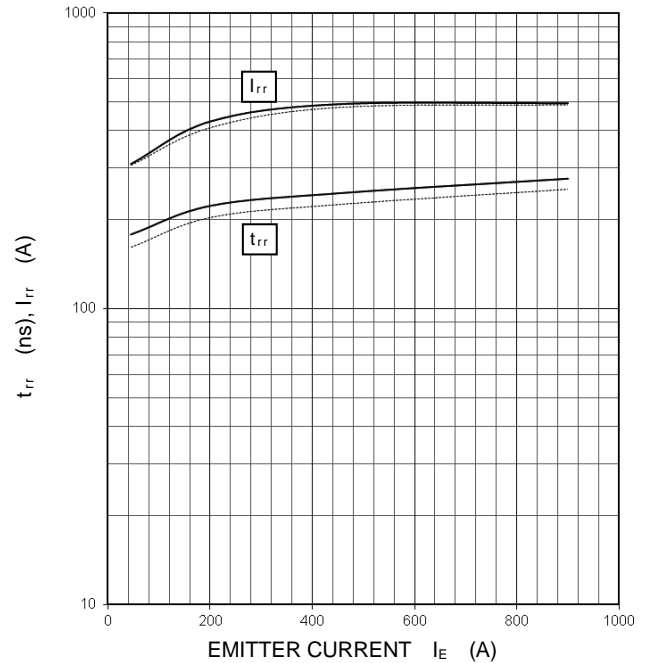

#### GATE CHARGE CHARACTERISTICS

(TYPICAL)

$V_{CC}=600\text{ V}$ ,  $I_C=450\text{ A}$ ,  $T_{vj}=25\text{ }^{\circ}\text{C}$

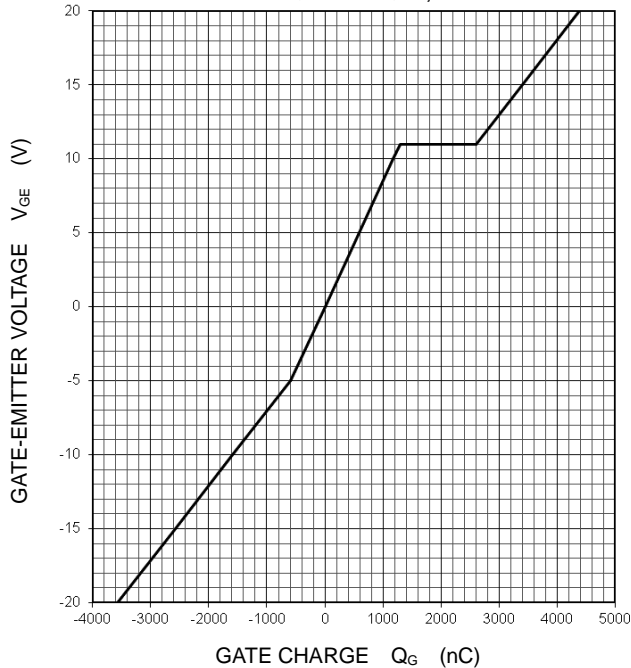

#### TRANSIENT THERMAL IMPEDANCE CHARACTERISTICS

(MAXIMUM)

Single pulse,  $T_C=25\text{ }^{\circ}\text{C}$   
 $R_{th(j-c)Q}=60\text{ K/kW}$ ,  $R_{th(j-c)D}=87\text{ K/kW}$

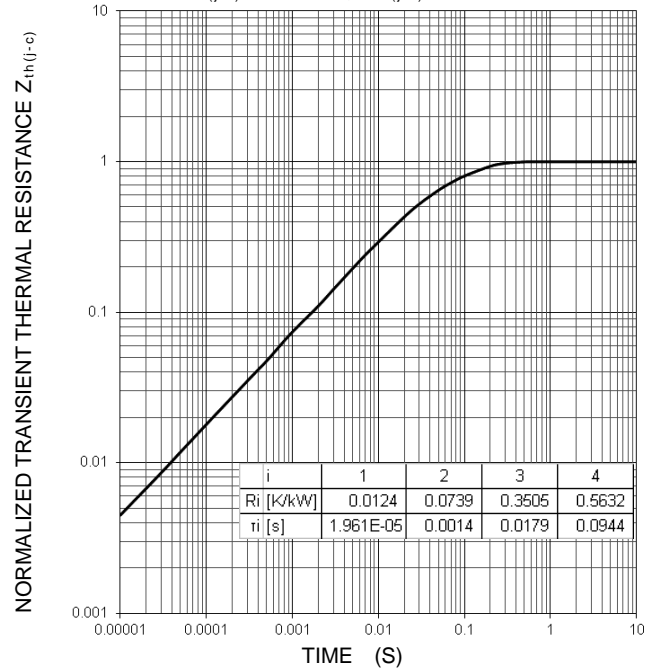

# CM450DX-24T/CM450DXP-24T

HIGH POWER SWITCHING USE  
INSULATED TYPE

## PERFORMANCE CURVES

### INVERTER PART

**TURN-OFF SWITCHING SAFE OPERATING AREA  
(REVERSE BIAS SAFE OPERATING AREA)  
(MAXIMUM)**

$V_{CC} \leq 850 \text{ V}$ ,  $R_G = 1.3 \sim 10 \ \Omega$ ,  $V_{GE} = \pm 15 \text{ V}$ ,  
 ———:  $T_{vj} = 25 \sim 150 \text{ }^\circ\text{C}$  (Normal load operations (Continuous))  
 - - - - -:  $T_{vj} = 175 \text{ }^\circ\text{C}$  (Unusual load operations (Limited period))

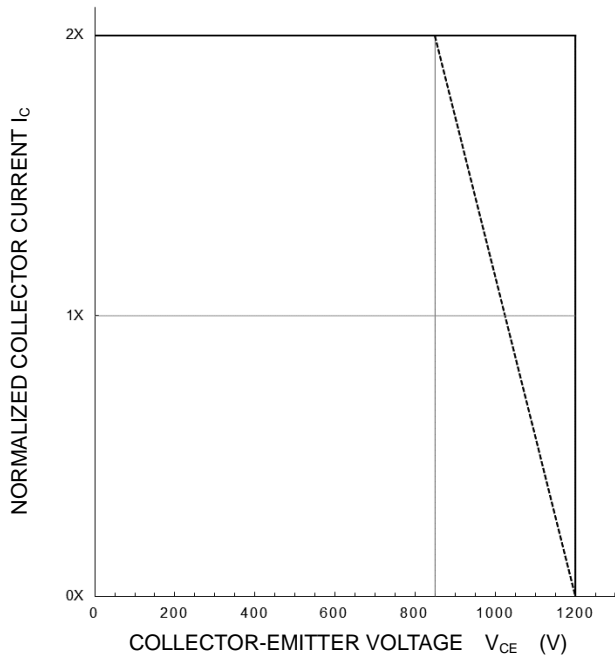

**SHORT-CIRCUIT SAFE OPERATING AREA  
(MAXIMUM)**

$V_{CC} \leq 800 \text{ V}$ ,  $R_G = 1.3 \sim 10 \ \Omega$ ,  $V_{GE} = \pm 15 \text{ V}$ ,  
 $T_{vj} = 25 \sim 150 \text{ }^\circ\text{C}$ ,  $t_W \leq 8 \ \mu\text{s}$ , Non-Repetitive

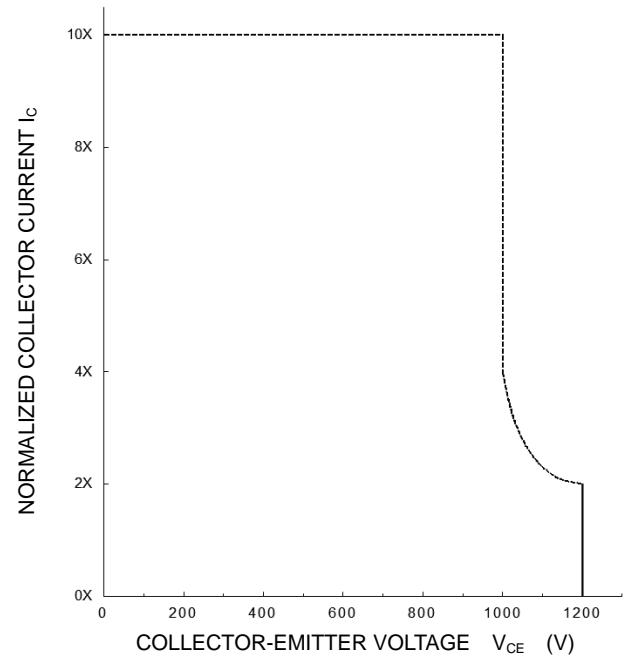

### NTC thermistor part

**TEMPERATURE CHARACTERISTICS  
(TYPICAL)**

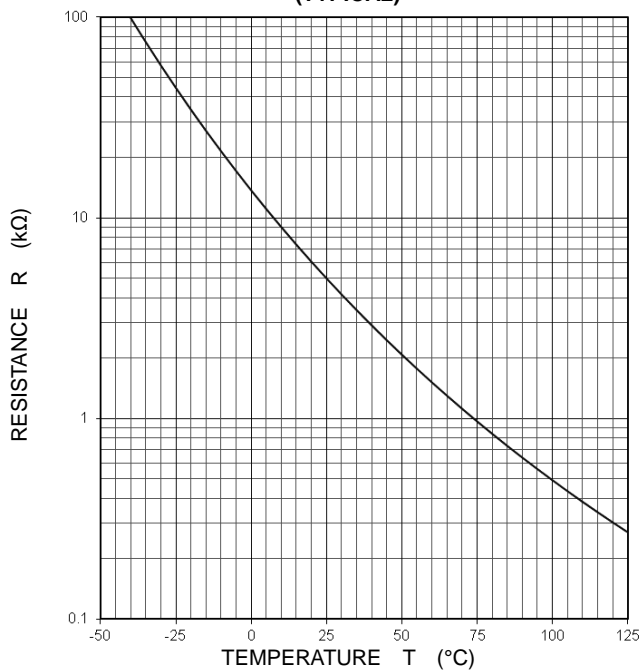

Note: The characteristics curves are presented for reference only and not guaranteed by production test, unless otherwise noted.

### **Keep safety first in your circuit designs!**

Mitsubishi Electric Corporation puts the maximum effort into making semiconductor products better and more reliable, but there is always the possibility that trouble may occur with them. Trouble with semiconductors may lead to personal injury, fire or property damage. Remember to give due consideration to safety when making your circuit designs, with appropriate measures such as (i) placement of substitutive, auxiliary circuits, (ii) use of non-flammable material or (iii) prevention against any malfunction or mishap.

### **Notes regarding these materials**

- These materials are intended as a reference to assist our customers in the selection of the Mitsubishi semiconductor product best suited to the customer's application; they do not convey any license under any intellectual property rights, or any other rights, belonging to Mitsubishi Electric Corporation or a third party.
- Mitsubishi Electric Corporation assumes no responsibility for any damage, or infringement of any third-party's rights, originating in the use of any product data, diagrams, charts, programs, algorithms, or circuit application examples contained in these materials.
- All information contained in these materials, including product data, diagrams, charts, programs and algorithms represents information on products at the time of publication of these materials, and are subject to change by Mitsubishi Electric Corporation without notice due to product improvements or other reasons. It is therefore recommended that customers contact Mitsubishi Electric Corporation or an authorized Mitsubishi Semiconductor product distributor for the latest product information before purchasing a product listed herein.  
The information described here may contain technical inaccuracies or typographical errors. Mitsubishi Electric Corporation assumes no responsibility for any damage, liability, or other loss rising from these inaccuracies or errors.  
Please also pay attention to information published by Mitsubishi Electric Corporation by various means, including the Mitsubishi Semiconductor home page ([www.MitsubishiElectric.com/semiconductors/](http://www.MitsubishiElectric.com/semiconductors/)).
- When using any or all of the information contained in these materials, including product data, diagrams, charts, programs, and algorithms, please be sure to evaluate all information as a total system before making a final decision on the applicability of the information and products. Mitsubishi Electric Corporation assumes no responsibility for any damage, liability or other loss resulting from the information contained herein.
- Mitsubishi Electric Corporation semiconductors are not designed or manufactured for use in a device or system that is used under circumstances in which human life is potentially at stake. Please contact Mitsubishi Electric Corporation or an authorized Mitsubishi Semiconductor product distributor when considering the use of a product contained herein for any specific purposes, such as apparatus or systems for transportation, vehicular, medical, aerospace, nuclear, or undersea repeater use.
- The prior written approval of Mitsubishi Electric Corporation is necessary to reprint or reproduce in whole or in part these materials.
- If these products or technologies are subject to the Japanese export control restrictions, they must be exported under a license from the Japanese government and cannot be imported into a country other than the approved destination.  
Any diversion or reexport contrary to the export control laws and regulations of Japan and/or the country of destination is prohibited.
- Please contact Mitsubishi Electric Corporation or an authorized Mitsubishi Semiconductor product distributor for further details on these materials or the products contained therein.

Generally the listed company name and the brand name are the trademark of the companies or registered trademarks.