

CM400E4G-130H

HIGH POWER SWITCHING USE
INSULATED TYPE

Prepared by	K.Kurachi	Revision: B
Date	I.Umezaki	24-Feb.-2009

3th-Version HVIGBT (High Voltage Insulated Gate Bipolar Transistor) Modules

CM400E4G-130H



- I_C 400 A
- V_{CES} 6500 V
- 1-element in a Pack (for brake chopper)
- Insulated Type
- AISiC Baseplate

APPLICATION

Traction drives, High Reliability Converters / Inverters, DC choppers

OUTLINE DRAWING & CIRCUIT DIAGRAM

Dimensions in mm

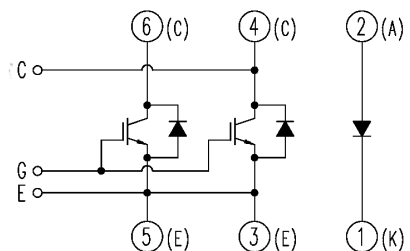
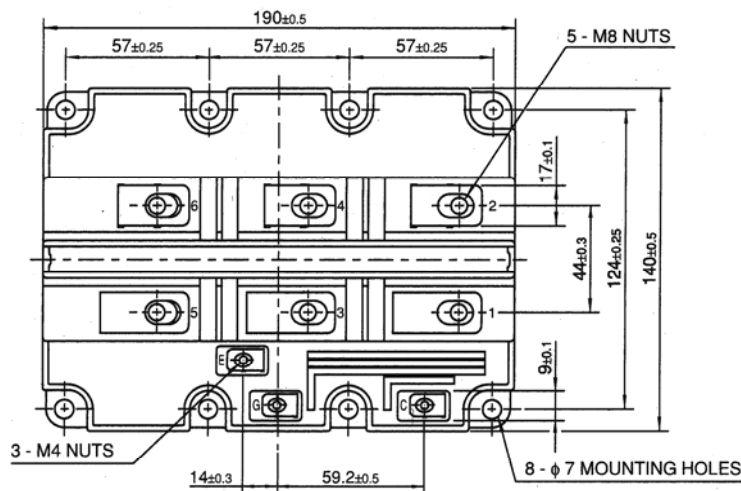

接続図
CIRCUIT DIAGRAM

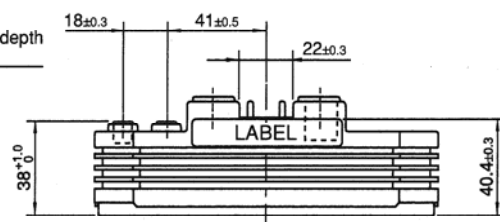
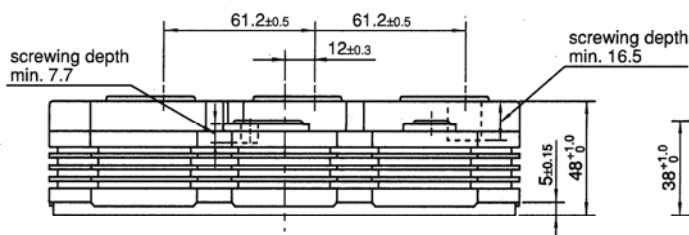

CM400E4G-130H

HIGH POWER SWITCHING USE
INSULATED TYPE

3th-Version HVIGBT (High Voltage Insulated Gate Bipolar Transistor) Modules

MAXIMUM RATINGS

Symbol	Item	Conditions	Ratings		Unit
V _{CES}	Collector-emitter voltage	V _{GE} = 0 V	T _j = -40 °C	5800	V
			T _j = +25 °C	6300	
			T _j = +125 °C	6500	
V _{GES}	Gate-emitter voltage	V _{CE} = 0V, T _j = 25°C		± 20	V
I _C	Collector current	DC, T _c = 80°C		400	A
I _{CM}		Pulse (Note 1)		800	A
I _E	Emitter current (Note 2)	DC		400	A
I _{EM}		Pulse (Note 1)		800	A
P _c	Maximum power dissipation (Note 3)	T _c = 25°C, IGBT part		5900	W
V _{iso}	Isolation voltage	RMS, sinusoidal, f = 60Hz, t = 1 min.		10200	V
V _e	Partial discharge extinction voltage	RMS, sinusoidal, f = 60Hz, Q _{PD} ≤ 10 pC		5100	V
T _j	Junction temperature			-40 ~ +150	°C
T _{op}	Operating temperature			-40 ~ +125	°C
T _{stg}	Storage temperature			-40 ~ +125	°C
t _{psc}	Maximum short circuit pulse width	V _{CC} = 4500V, V _{CE} ≤ V _{CES} , V _{GE} = 15V, T _j = 125°C		10	µs

ELECTRICAL CHARACTERISTICS

Symbol	Item	Conditions	Limits			Unit	
			Min	Typ	Max		
I _{CES}	Collector cutoff current	V _{CE} = V _{CES} , V _{GE} = 0V	T _j = 25°C	—	—	7	mA
			T _j = 125°C	—	20	60	
V _{GE(th)}	Gate-emitter threshold voltage	V _{CE} = 10 V, I _C = 40 mA, T _j = 25°C	5.0	6.0	7.0	V	
I _{GES}	Gate leakage current	V _{GE} = V _{GES} , V _{CE} = 0V, T _j = 25°C	-0.5	—	0.5	µA	
C _{ies}	Input capacitance	V _{CE} = 10 V, V _{GE} = 0 V, f = 100 kHz T _j = 25°C	—	82.0	—	nF	
C _{oes}	Output capacitance		—	5.0	—	nF	
C _{res}	Reverse transfer capacitance		—	1.4	—	nF	
Q _g	Total gate charge	V _{CC} = 3600 V, I _C = 400 A V _{GE} = ±15 V, T _j = 25 °C	—	6.6	—	µC	
V _{CE(sat)}	Collector-emitter saturation voltage	I _C = 400 A (Note 4) V _{GE} = 15 V	T _j = 25°C	—	4.5	—	V
			T _j = 125°C	—	4.6	—	
t _{d(on)}	Turn-on delay time	V _{CC} = 3600 V, I _C = 400 A V _{GE} = ±15 V, R _{G(on)} = 15 Ω T _j = 125 °C, L _s = 170 nH	—	1.2	—	µs	
t _r	Turn-on rise time		—	0.35	—	µs	
E _{on(10%)}	Turn-on switching energy (Note 5)		t _(IGBT_off) = 60 µs (Note 6), Inductive load	—	3.0	—	J/P
t _{d(off)}	Turn-off delay time	V _{CC} = 3600 V, I _C = 400 A V _{GE} = ±15 V, R _{G(off)} = 50 Ω T _j = 125 °C, L _s = 170 nH	—	8.2	—	µs	
t _f	Turn-off fall time		—	0.5	—	µs	
t _{f2}	Turn-off fall time		—	3.1	—	µs	
E _{off(10%)}	Turn-off switching energy (Note 5)		Inductive load	—	2.7	—	J/P
V _{EC}	Emitter-collector voltage (Note 2)	I _E = 400 A (Note 4) V _{GE} = 0 V	T _j = 25 °C	—	4.0	—	V
			T _j = 125 °C	—	3.6	—	
t _{rr}	Reverse recovery time (Note 2)	V _{CC} = 3600 V, I _E = 400 A V _{GE} = ±15 V, R _{G(on)} = 15 Ω T _j = 125 °C, L _s = 170 nH	—	1.0	—	µs	
t _{rr2}	Reverse recovery time (Note 2)		—	2.4	—	µs	
Q _{rr}	Reverse recovery charge (Note 2)		—	740	—	µC	
E _{rec(10%)}	Reverse recovery energy (Note 2), (Note 5)		t _(IGBT_off) = 60 µs (Note 6), Inductive load	—	1.4	—	J/P

HVIGBT (High Voltage Insulated Gate Bipolar Transistor) MODULES



CM400E4G-130H

HIGH POWER SWITCHING USE
INSULATED TYPE

3th-Version HVIGBT (High Voltage Insulated Gate Bipolar Transistor) Modules

THERMAL CHARACTERISTICS

Symbol	Item	Conditions	Limits			Unit
			Min	Typ	Max	
$R_{th(j-c)Q}$	Thermal resistance	Junction to Case, IGBT part	—	—	21.0	K/kW
$R_{th(j-c)R}$	Thermal resistance	Junction to Case, FWDi part	—	—	33.0	K/kW
		Junction to Case, Clamp-Di part	—	—	33.0	K/kW
$R_{th(c-f)}$	Contact thermal resistance	Case to Fin, $\lambda_{grease} = 1W/m \cdot K$, $D_{(c-f)} = 100 \mu m$	—	9.0	—	K/kW

MECHANICAL CHARACTERISTICS

Symbol	Item	Conditions	Limits			Unit
			Min	Typ	Max	
M_t	Mounting torque	M8: Main terminals screw	7.0	—	15.0	N·m
M_s		M6: Mounting screw	3.0	—	6.0	N·m
M_t		M4: Auxiliary terminals screw	1.0	—	3.0	N·m
m	Mass		—	1.35	—	kg
CTI	Comparative tracking index		600	—	—	—
d_a	Clearance		26.0	—	—	mm
d_s	Creepage distance		56.0	—	—	mm
L_{PCE}	Parasitic stray inductance	Collector to Emitter	—	27.0	—	nH
		Anode to Cathode	—	54.0	—	nH
R_{CC+EE}	Internal lead resistance	$T_c = 25^\circ C$, Collector to Emitter	—	0.19	—	m Ω
		$T_c = 25^\circ C$, Anode to Cathode	—	0.38	—	m Ω

- Note 1. Pulse width and repetition rate should be such that junction temperature (T_j) does not exceed T_{opmax} rating (125°C).
- Note 2. The symbols represent characteristics of the anti-parallel, emitter to collector free-wheel diode (FWDi) and the brake chopper, anode to cathode clamp diode (Clamp-Di).
- Note 3. Junction temperature (T_j) should not exceed T_{jmax} rating (150°C).
- Note 4. Pulse width and repetition rate should be such as to cause negligible temperature rise.
- Note 5. $E_{on(10\%)} / E_{off(10\%)} / E_{rec(10\%)}$ are the integral of $0.1V_{CE} \times 0.1I_C \times dt$.
- Note 6. $t_{(IGBT_off)}$ definition is shown as follows.

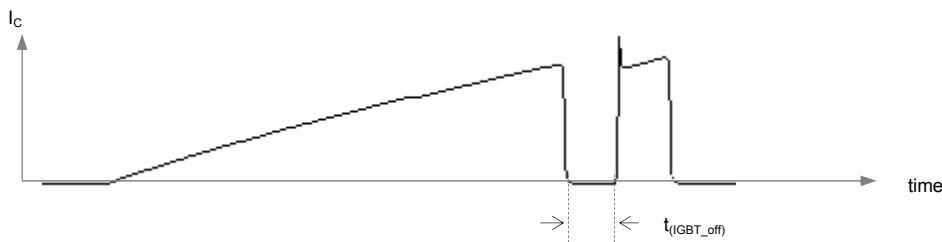

MITSUBISHI HVIGBT MODULES
CM400E4G-130H

HIGH POWER SWITCHING USE
 INSULATED TYPE

3th-Version HVIGBT (High Voltage Insulated Gate Bipolar Transistor) Modules

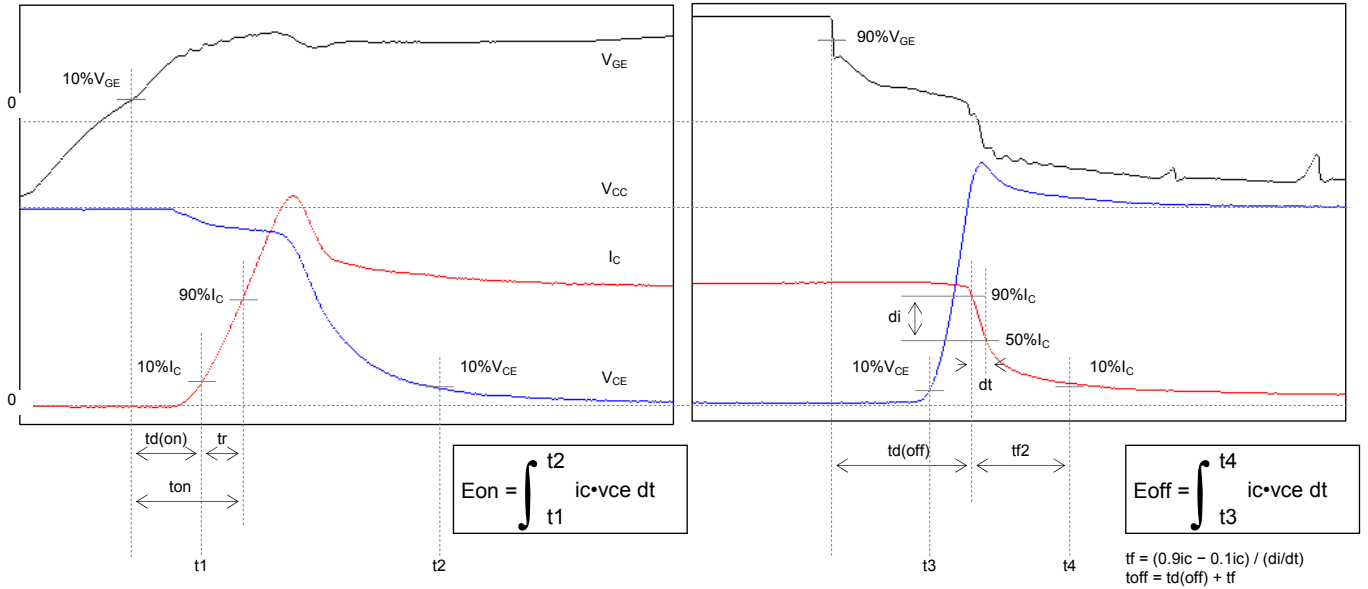

Fig. 2 – Definitions of switching times & energies of IGBT part

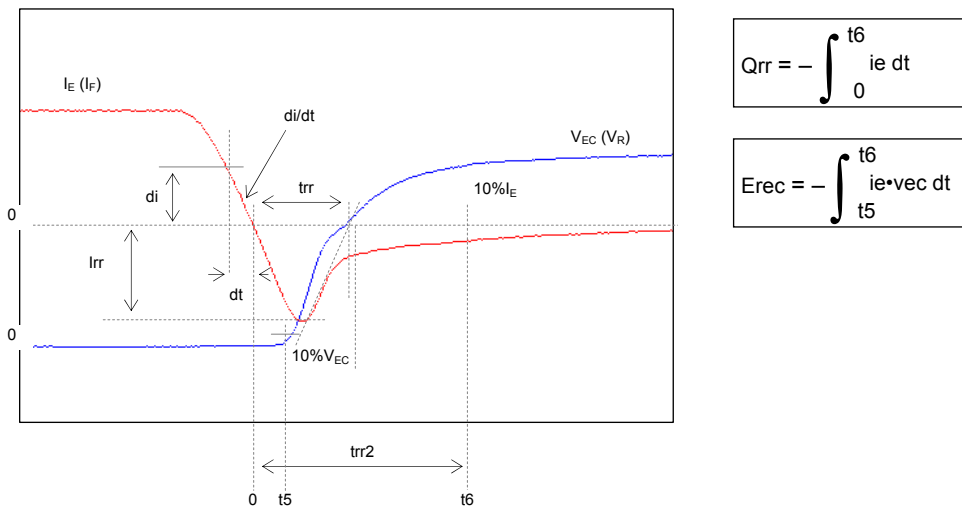

Fig. 3 – Definitions of reverse recovery charge & energy of FWDi part

CM400E4G-130H

HIGH POWER SWITCHING USE
INSULATED TYPE

3rd-Version HVIGBT (High Voltage Insulated Gate Bipolar Transistor) Modules

PERFORMANCE CURVES

OUTPUT CHARACTERISTICS (TYPICAL)

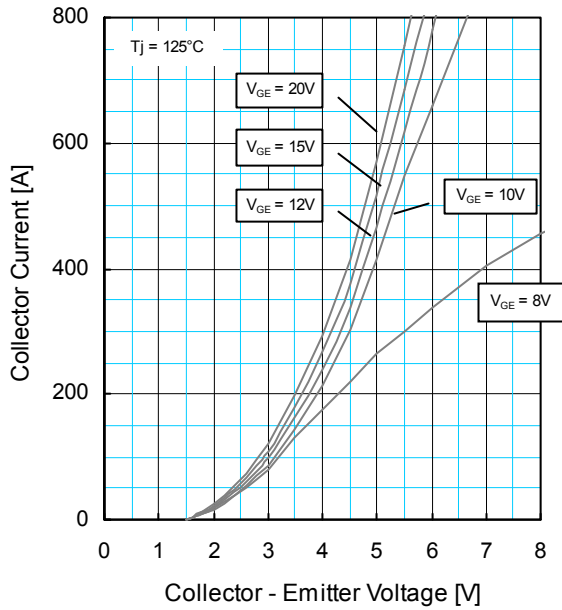

TRANSFER CHARACTERISTICS (TYPICAL)

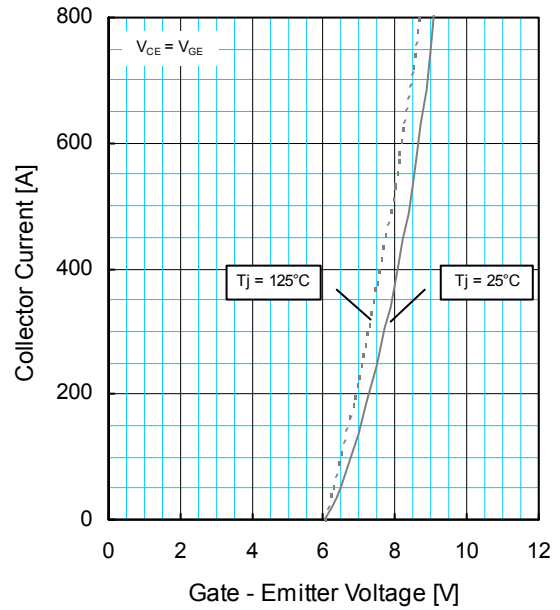

COLLECTOR-EMITTER SATURATION VOLTAGE CHARACTERISTICS (TYPICAL)

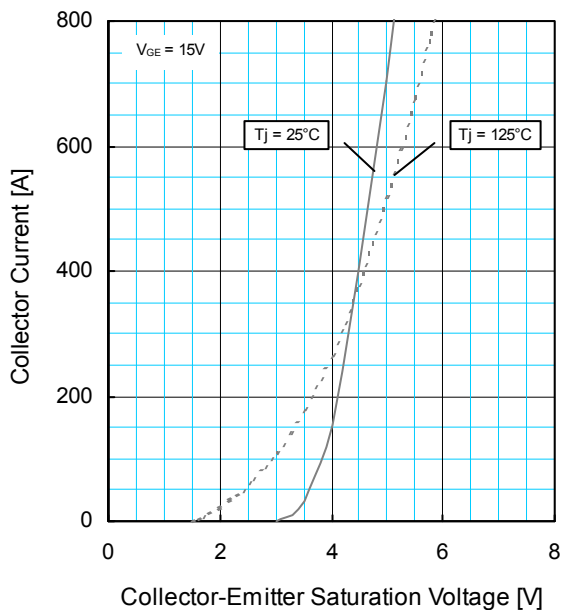

FREE-WHEEL DIODE FORWARD CHARACTERISTICS (TYPICAL)

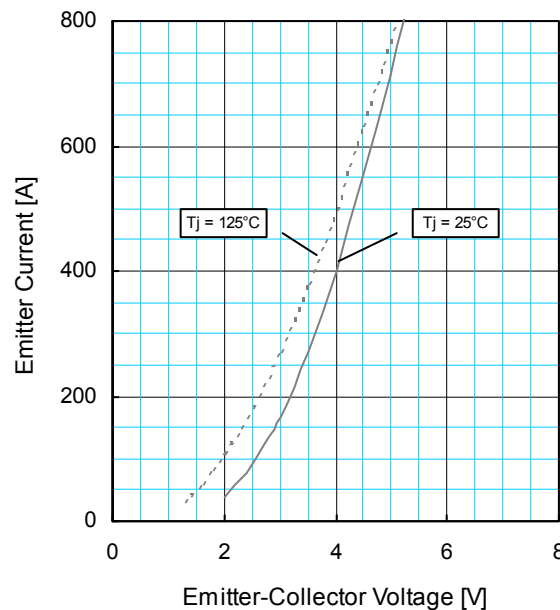

CM400E2G-130H

HIGH POWER SWITCHING USE
INSULATED TYPE

3rd-Version HVIGBT (High Voltage Insulated Gate Bipolar Transistor) Modules

PERFORMANCE CURVES

CAPACITANCE CHARACTERISTICS (TYPICAL)

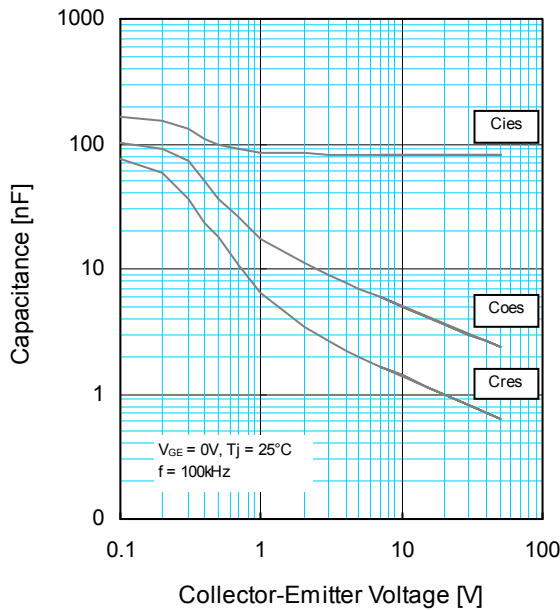

GATE CHARGE CHARACTERISTICS (TYPICAL)

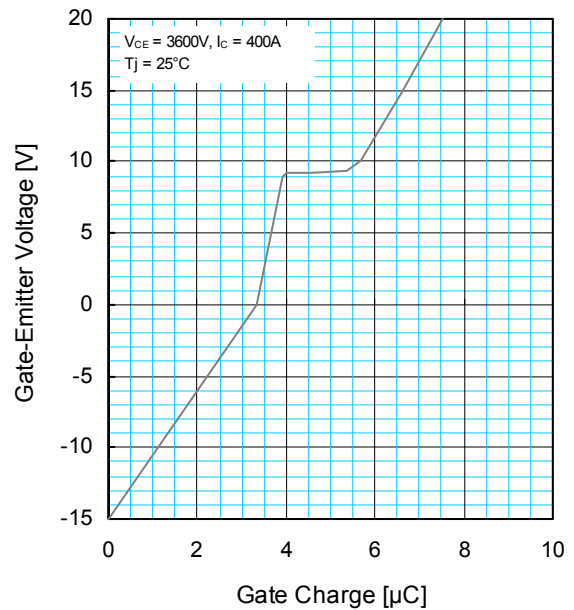

HALF-BRIDGE SWITCHING ENERGY CHARACTERISTICS (TYPICAL)

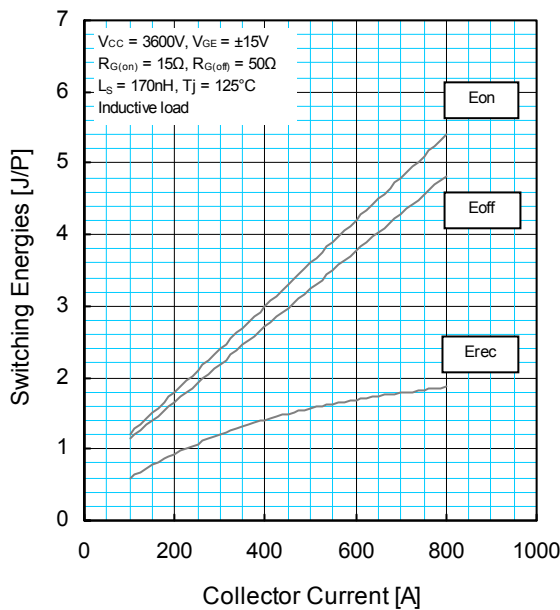

HALF-BRIDGE SWITCHING ENERGY CHARACTERISTICS (TYPICAL)

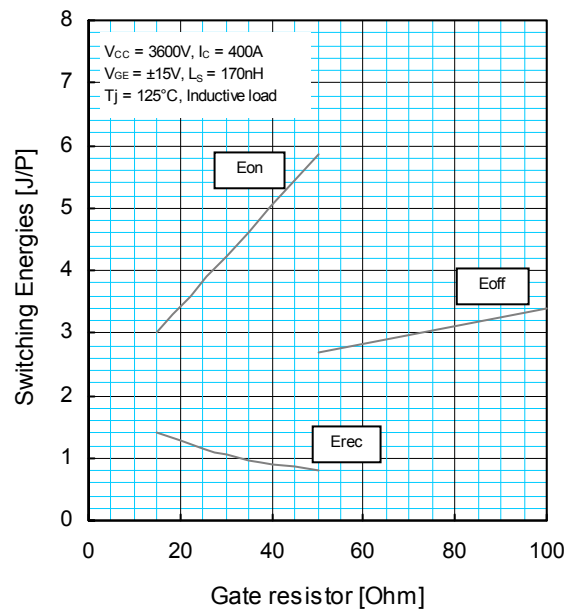

PERFORMANCE CURVES

HALF-BRIDGE SWITCHING TIME CHARACTERISTICS (TYPICAL)

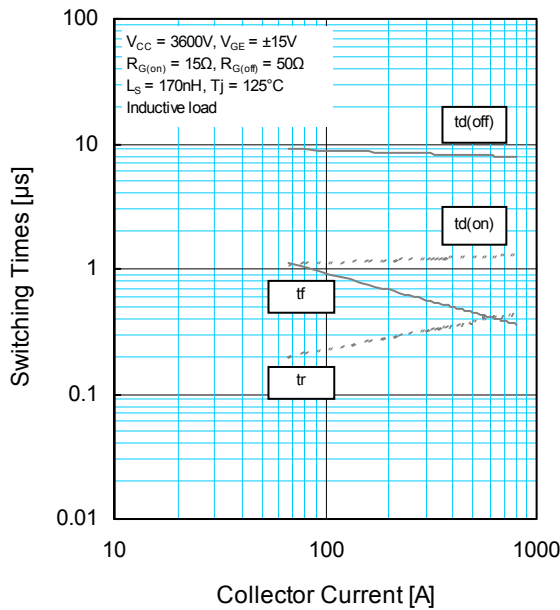

FREE-WHEEL DIODE REVERSE RECOVERY CHARACTERISTICS (TYPICAL)

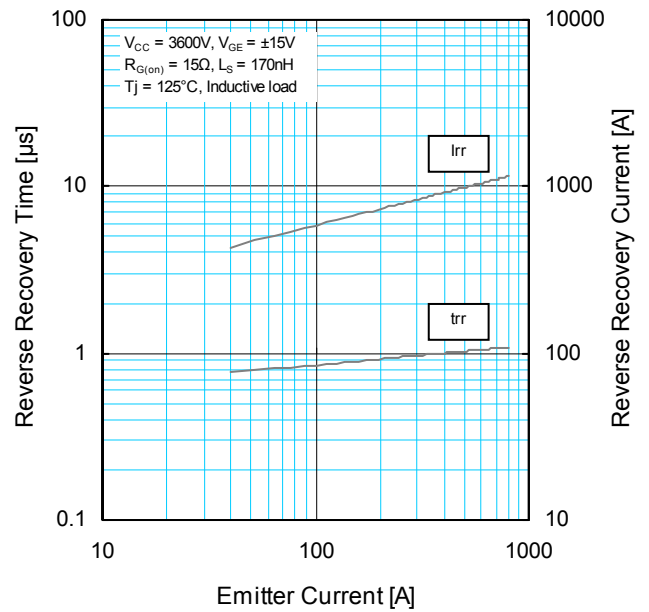

TRANSIENT THERMAL IMPEDANCE CHARACTERISTICS

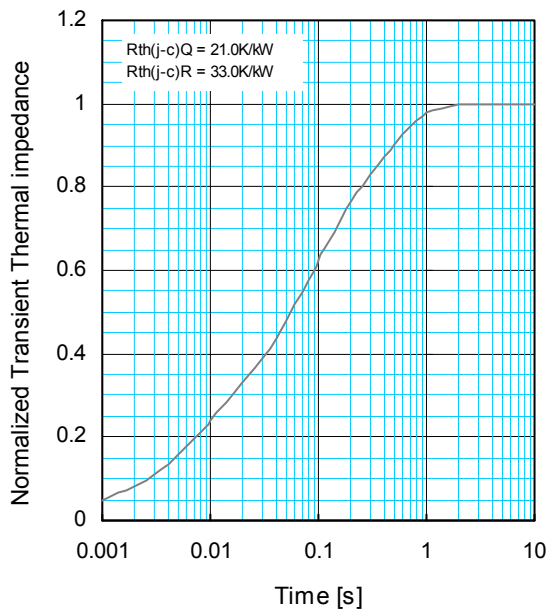

$$Z_{th(j-c)}(t) = \sum_{i=1}^n R_i \left\{ 1 - \exp\left(-\frac{t}{\tau_i}\right) \right\}$$

	1	2	3	4
R_i [K/kW] :	0.0096	0.1893	0.4044	0.3967
τ_i [sec] :	0.0001	0.0058	0.0602	0.3512

CM400E2G-130H

HIGH POWER SWITCHING USE
INSULATED TYPE

3th-Version HVIGBT (High Voltage Insulated Gate Bipolar Transistor) Modules

PERFORMANCE CURVES

REVERSE BIAS SAFE OPERATING AREA (RBSOA)

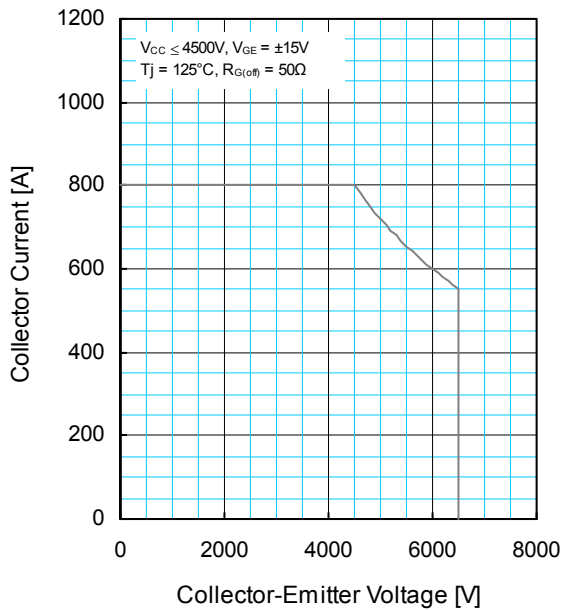

SHORT CIRCUIT SAFE OPERATING AREA (SCSOA)

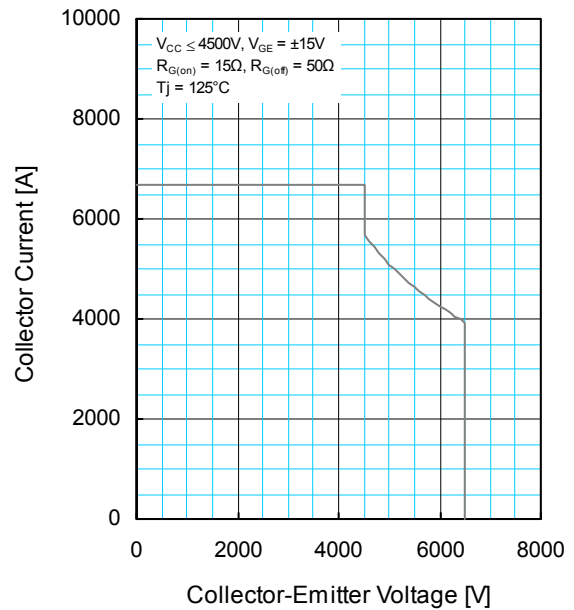

FREE-WHEEL DIODE REVERSE RECOVERY SAFE OPERATING AREA (RRSOA)

